

# Trapezio

## Installation Instructions

OPTIQUE

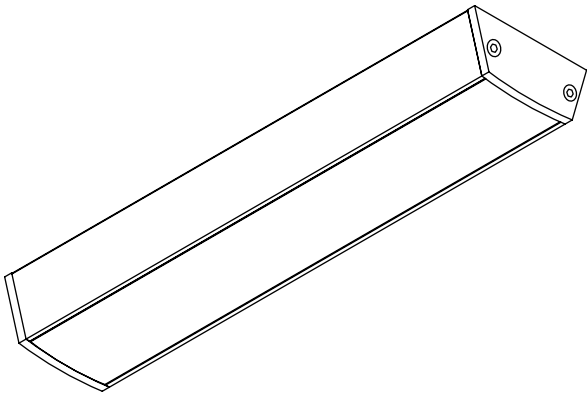

### Safety and Warnings

1. Install in accordance with national and local electrical code regulations.
2. This product is intended to be installed and serviced by a qualified, licensed electrician.
3. Do not modify or disassemble this product beyond instructions or the warranty will be void.
4. Do not install near areas with exposure to water unless it is a Wet Location tape.
5. Do not attempt to fix this product in the field.
6. Failure to follow safety warnings, and installation instructions will void the warranty for this product.

### Tools for Install

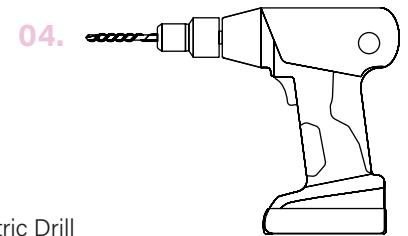
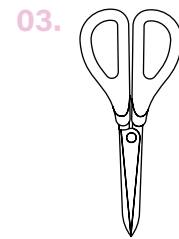
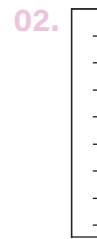
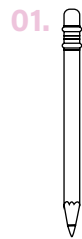

01. Pencil
02. Ruler
03. Scissors
04. Screwdriver or Electric Drill

### Installation

#### 01.

Prepare mounting surface by removing any dirt, debris or moisture.

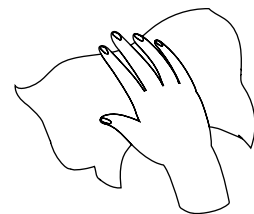
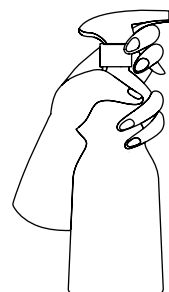

# Trapezio

## Installation Instructions

OPTIQUE

### 02.

Draw guideline for mounting clips with a ruler and pencil.

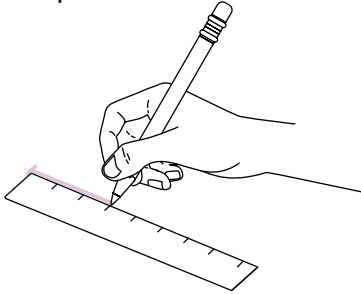

### 03.

Mount fixture with mounts or VHB Tape.

#### 3a. Mounting Clips

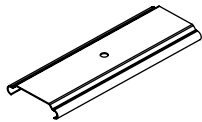

1. Mark holes. Use one clip for every two feet for channel. Fasten with included screws with screwdriver or drill.

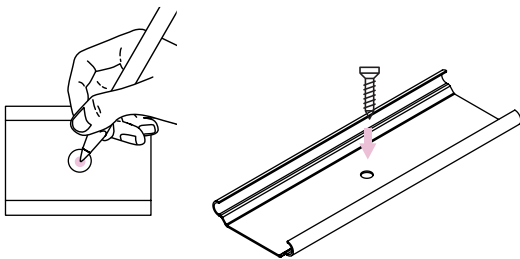

2. Press one edge of channel into mounting clip. Press other edge of channel into mounting clip.

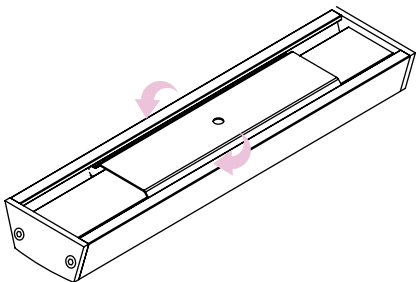

- 3b. Apply 3M VHB adhesive to back of channel.

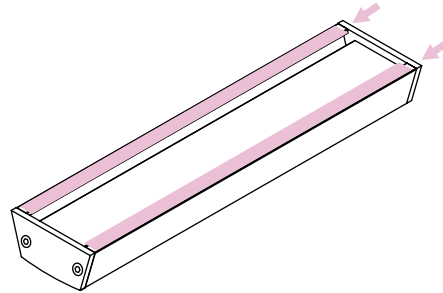

### 04.

Connect Trapezio to power supply.

