

Pivotaire

Zig-Zag Installation Instructions

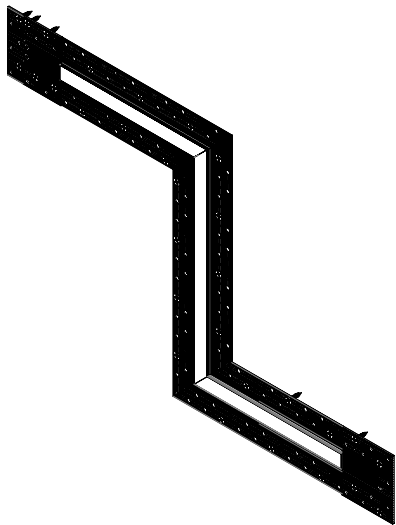

Required Tools

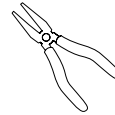

FLAT PLIERS

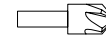

COUNTERSINK
DRILL BIT

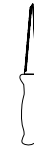

JAB SAW



PAINTER'S TAPE



JOINT KNIFE

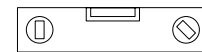

LEVEL BAR

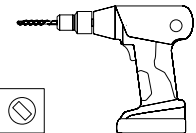

POWER DRILL

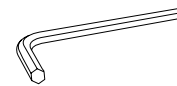

1.5MM ALLEN KEY

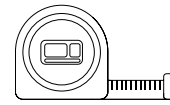

TAPE MEASURE

Important Information

- These instructions show a typical installation.
- This product is compatible with 5/8" inch drywall.

Safety and Warnings

1. Install in accordance with the national and local electrical code.
2. This product is intended to be installed and serviced by a qualified, licensed electrician.
3. Failure to follow safety warnings and installation instructions will void the product warranty.

Supplied Components

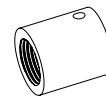

WIRE STRAIN
RELIEF

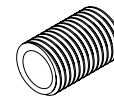

THREADED PIPE



LOCK WASHER



HEX NUT



AMPCHAM

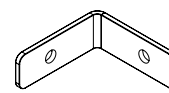

L-BRACKET FOR
MITER CORNERS

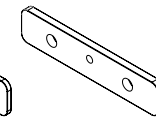

STRAIGHT
CONNECTING
BRACKET



SET SCREW

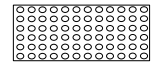

DRYWALL ANCHOR



HEX SCREW

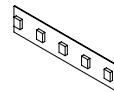

TAPE LIGHT

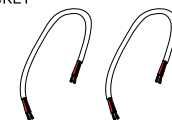

18 AWG WIRE

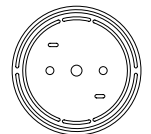

MOUNTING PLATE

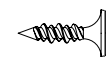

5/8" DRYWALL
SCREW



TSGB MOUNTING
SCREW



TSGB

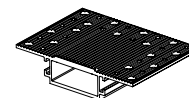

NON-POWERED
ENDCAP

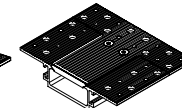

POWERED
ENDCAP



CUSTOM MITER CUT
PIVOTAIRE CHANNEL

Pivotaire

Zig-Zag Installation Instructions

✂ Section One: Install the Remote Power Supply

01.

Install a 24V remote power supply and run low voltage in-wall rated wire to the desired location.

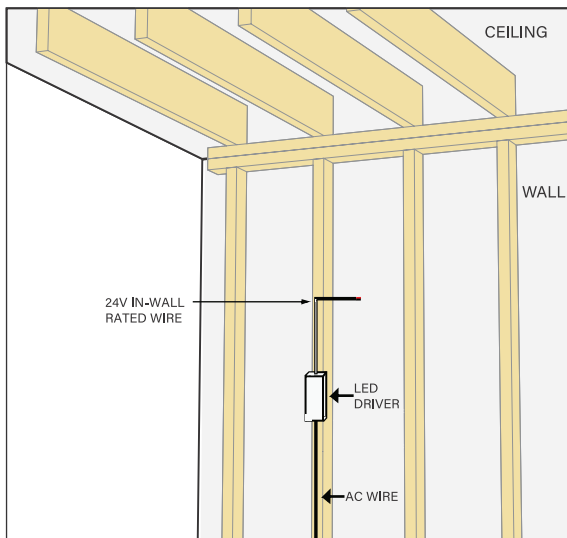

✂ Section Two: Mounting Plate Installation

01.

Bend TSGB so that the junction box is flush against the back surface of the drywall that will be installed.

02.

Splice low voltage wire so that the single positive connector becomes two and the single negative connector becomes two using included 18 AWG wire.

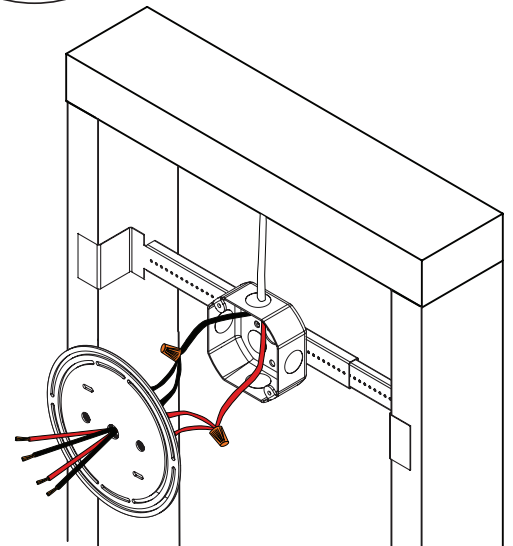
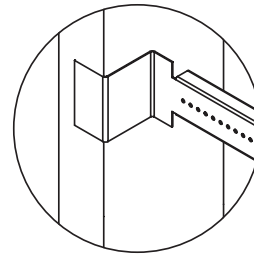

Pivotaire

Zig-Zag Installation Instructions

03.

Screw the threaded pipe into the threaded middle hole indicated below.

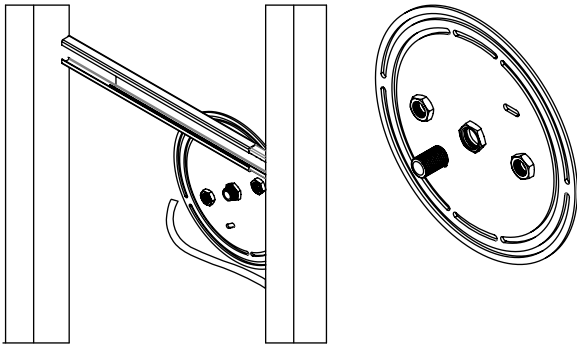

04.

Add the wire strain relief cap to the end of the threaded pipe behind the mounting plate.

- a. Ensure the threaded pipe protrudes 1/2" from the front of the mounting plate.

05.

Thread the 18 AWG low-voltage wires through the strain relief screw. Have wire protrude from the threaded pipe by about 6 inches. One positive (red) and one negative (black) wire per tape light.

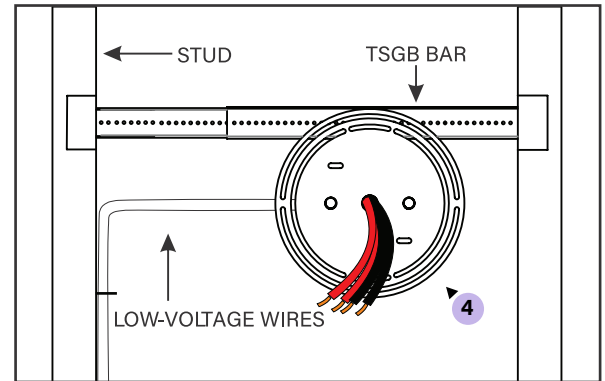
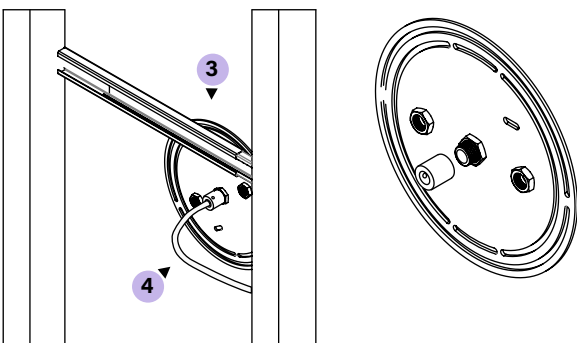

06.

Tighten the strain relief nylon set screw fitting so that it is snug on the wire insulation but not so tight that it damages the insulation.

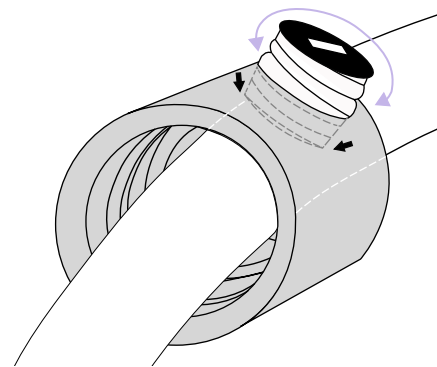

Pivotaire

Zig-Zag Installation Instructions

✂ Section Three: Drywall Installation

01.

Assemble the endcap and the channel according to the planned layout, using the straight connecting bracket to maintain alignment and the L-bracket for miter corners.

- Insert the straight bracket halfway into the channel rails. Tighten the two M3 set screws on each bracket using a 1.5mm Allen key.
- Slide the other section of the channel onto the L-bracket and tighten the remaining M3 set screws.

⚠ IMPORTANT: Make sure to position the powered endcap at the end to be powered.

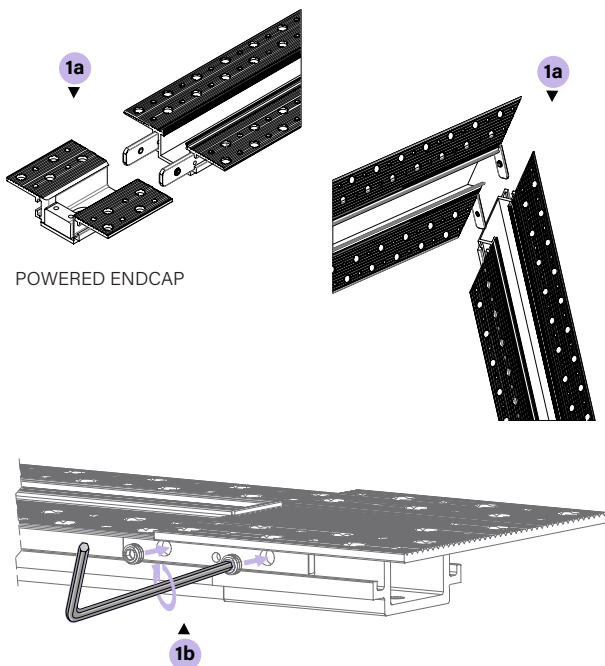

02.

Mark on the drywall where the mounting plate with the wires will be exposed. Drill $\frac{1}{2}$ " hole and cut the section using a jab saw to expose the mounting plate.

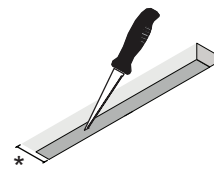

* Channel width varies between models.

- 0.5" Wide Channel
- 1" Wide Channel

03.

Install drywall.

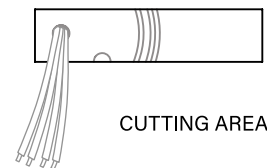

04.

Use the assembled fixture as a guide to mark on the wall where the fixture is to be mounted. Ensure that the hole in the powered endcap aligns with the threaded pipe.

NOTE: You can mount the fixture at any angle. These instructions show a horizontal/vertical installation though any angle can be used.

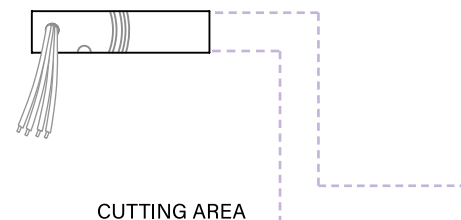

Pivotaire

Zig-Zag Installation Instructions

05.

Cut out the marked area matching the length and width of the channel.

- a. Allow for fixture wings to rest on outside of area.

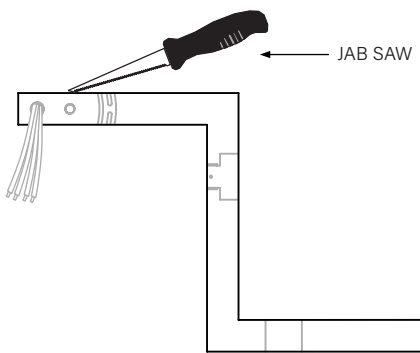

✂ Section Four: Mount Channel

NOTE: Optique recommends using drywall screws where studs are present for maximum strength.

If the installation area does not cross studs, please use included drywall anchor.

01.

Install a drywall anchor behind the drywall every 36" where studs are not available.

- a. Thread a drywall screw into the drywall anchor.
- b. Place the drywall anchor behind the precut drywall and rotate it into place using the drywall screw as a handle. Secure the drywall anchor to the drywall using two drywall screws.
- c. Mark the location of the drywall anchors on the drywall for future reference.

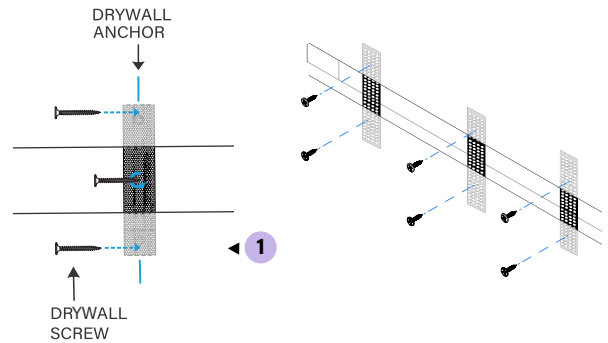

02.

Place the assembled fixture into the cutout area on the wall.

- a. Thread wire through the hole of the powered endcap. Insert into the precut drywall, aligning the hole of the powered endcap with the protruding threaded pipe.
- b. Secure the powered endcap by attaching the lock washer and hex nut to the threaded pipe. Use flat pliers to tighten the nut.

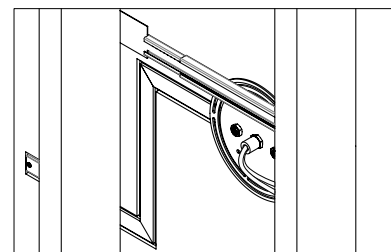
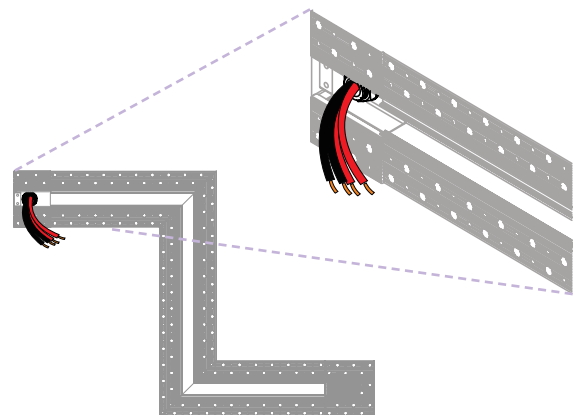

BACK VIEW

Pivotaire

Zig-Zag Installation Instructions

03.

Use supplied 5/8" drywall screws around Powered Endcap to ensure the screws do not impact the mounting plate.

- a. Use standard drywall screws to fasten the fixture to the wall. Properly secure the complete fixture to drywall by screwing through the wings. Use a countersink bit to ensure all screw heads are flush with the channel surface.

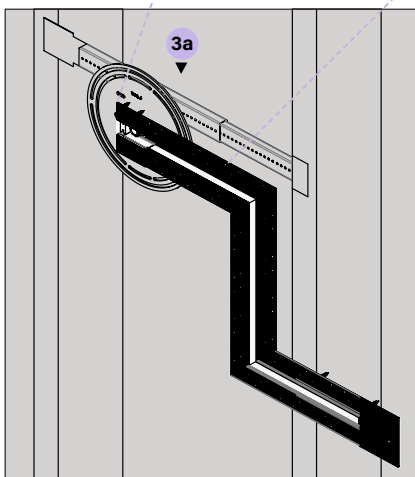
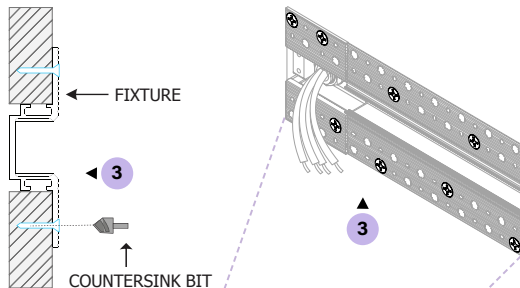

04.

Unwind the tape light from the supplied roll.



05.

Wire tape light to electrical supply using AmpChamps.

- a. Test the tape light by connecting a Class 2 LED driver. Turn on the power and ensure the tape lights up.
- b. Turn off the power again before mounting.

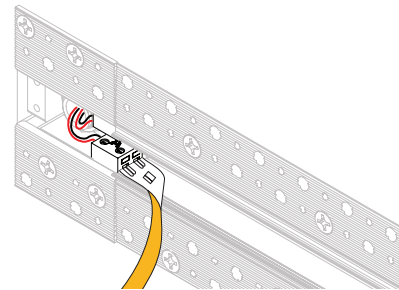

06.

Secure AmpChamps to the Pivotaire Powered Endcap with the edge lined up with the fixture using the included 3M VHB tapes.

- a. Connect the wire to the AmpChamps, leaving one inch of slack to ensure AmpChamps can be accessed after installation.

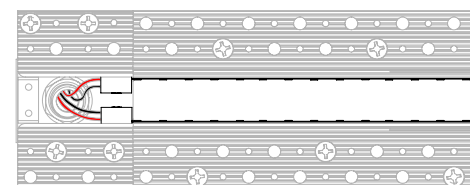
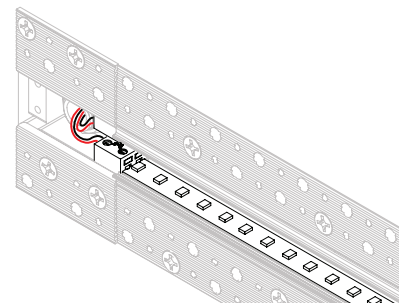

Pivotaire

Zig-Zag Installation Instructions

07.

Stick the tape light to the inside edges of the fixture.

- Carefully remove the tape protector from the bottom of the tape light.

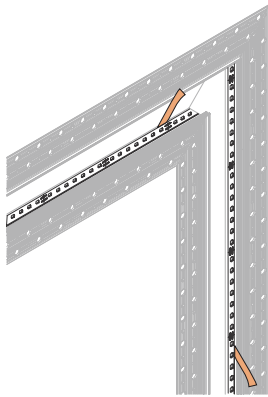

08.

Firmly pressing down using fingers, ensure the tape light is placed along the fixture edges removing the tape protector as needed.

- Ensure that the tape light is positioned in corners using your fingers. Do not use tools or hard objects to install the tape light.
- Tuck excess tape into the non-powered endcap.

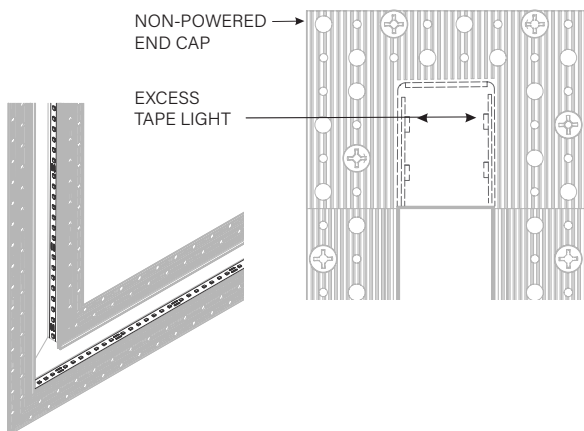

09.

Secure powered endcap cover with hex screws provided.

- Screw powered endcap cover to drywall using supplied 5/8" drywall screws.

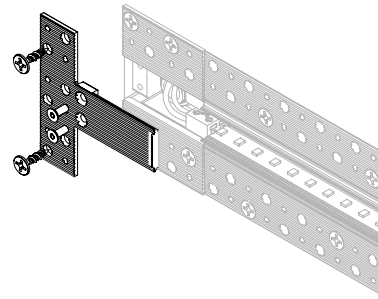

10.

Fasten the lens by firmly pressing one edge into the channel, then the other. Continue pressing the lens along the fixture until fully seated.

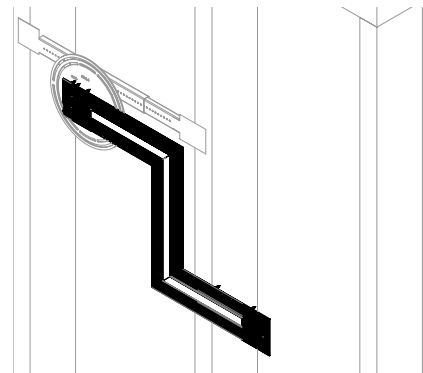
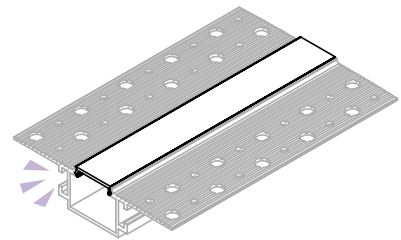

Pivotaire

Zig-Zag Installation Instructions

Section Five: Mud-in Channel

01.

Cover the center of the fixture with painter's tape.

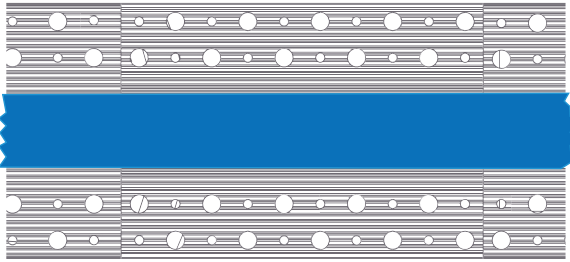

02.

Cover the wings of the fixture with thin drywall tape.

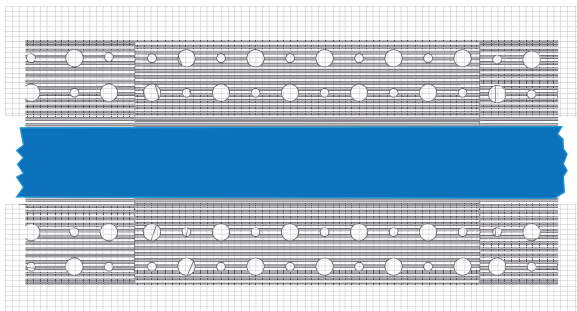

03.

Cover the wings of the fixture with mud.

- a. Wait until it is dry.
- b. Sand the wall.
- c. Repeat if necessary.



04.

Paint the wall and wait until it is dry.

05.

Remove painter's tape.

