

Rettangolo I, II & III

Installation Instructions

OPTIQUE

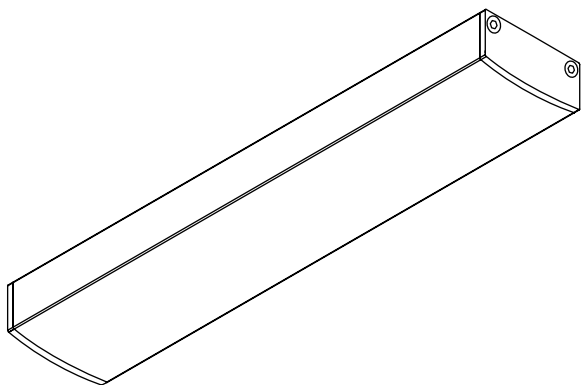

Safety and Warnings

1. Install in accordance with national and local electrical code regulations.
2. This product is intended to be installed and serviced by a qualified, licensed electrician.
3. Do not modify or disassemble this product beyond instructions or the warranty will be void.
4. Do not install near areas with exposure to water unless it is a Wet Location tape.
5. Do not attempt to fix this product in the field.
6. Failure to follow safety warnings, and installation instructions will void the warranty for this product.
7. Suitable for installation in the storage area of a clothes closet in the USA only.
8. **CAUTION:** To reduce the risk of fire, do not install in a compartment smaller than 24 inches by 24 inches by product length.

Tools for Install

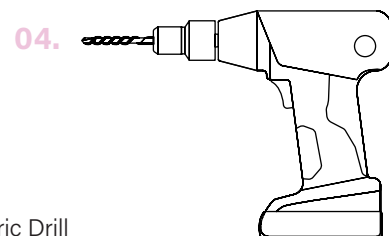
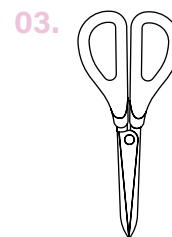
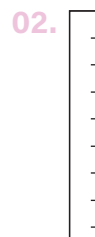
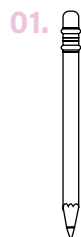

01. Pencil
02. Ruler
03. Scissors
04. Screwdriver or Electric Drill

Installation

01.

Prepare mounting surface by removing any dirt, debris or moisture.



Rettangolo I, II & III

Installation Instructions

02.

Draw guideline for mounting clips with a ruler and pencil.

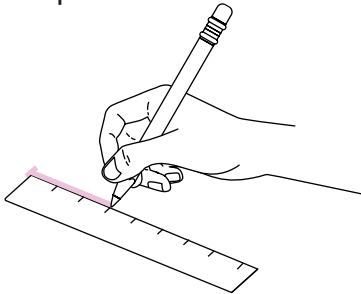

03.

Mount fixture with mounts or VHB Tape.

3a. Mounting Clips

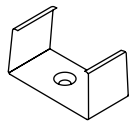

1. Mark holes. Use one clip for every two feet for profile. Fasten with included screws with screwdriver or drill.

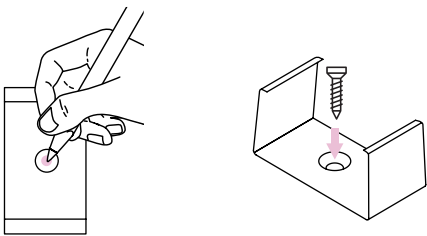

2. Press one edge of profile into mounting clip. Press other edge of profile into mounting clip.

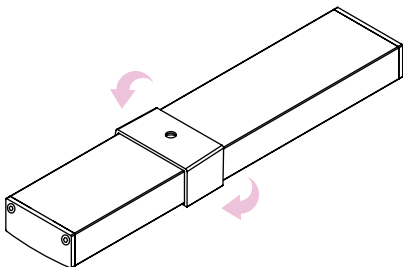

- 3b. Apply 3M VHB adhesive to back of profile.

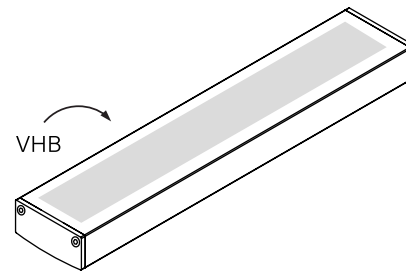

04.

Connect Rettangolo to power supply.

