

Pivotaire

Picture Frame Installation Instructions

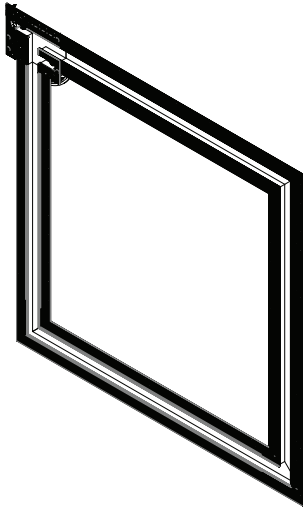

Required Tools

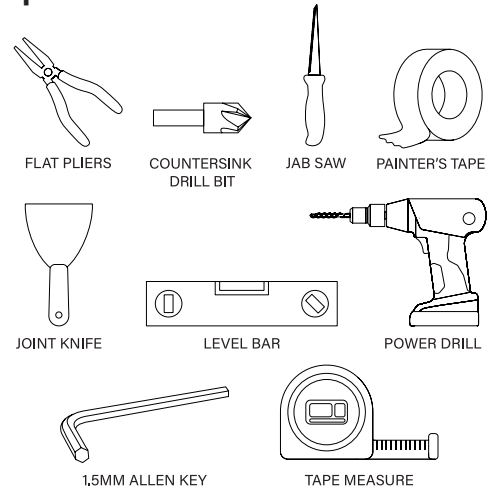

Supplied Components

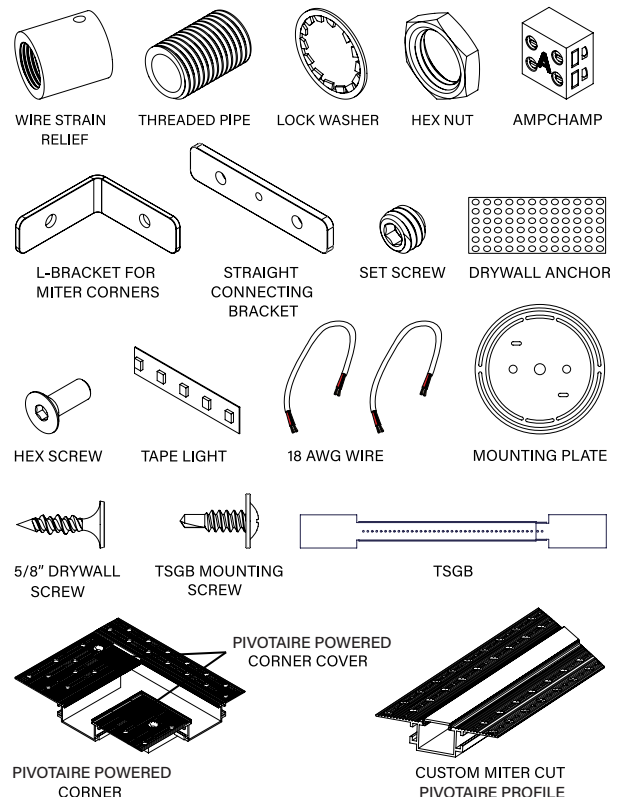

Important Information

- These instructions show a typical installation.
- This product is compatible with 5/8" inch drywall.

Safety and Warnings

1. Install in accordance with the national and local electrical code.
2. This product is intended to be installed and serviced by a qualified, licensed electrician.
3. Failure to follow safety warnings and installation instructions will void the product warranty.
4. Suitable for installation in the storage area of a clothes closet in the USA only.
5. **CAUTION:** To reduce the risk of fire, do not install in a compartment smaller than 24 inches by 24 inches by product length.
6. Access above ceiling or behind wall required.

Pivotaire

Picture Frame Installation Instructions

✂ Section One: Install the Remote Power Supply

01.

Install a 24V remote power supply and run low voltage in-wall rated wire to the desired location.

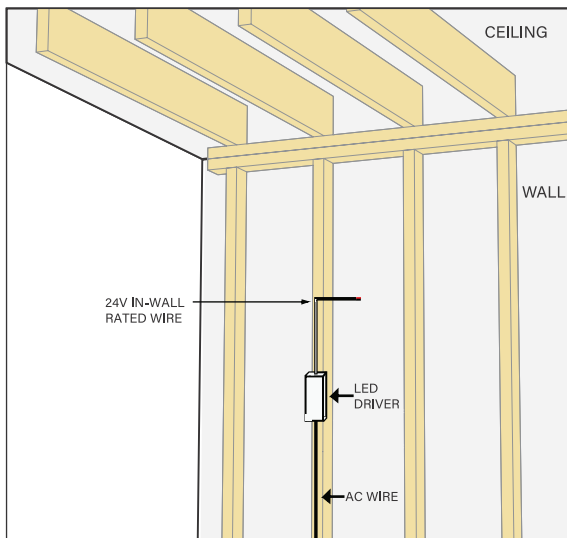

✂ Section Two: Mounting Plate Installation

01.

Bend TSGB so that the junction box is flush against the back surface of the drywall that will be installed.

02.

Splice low voltage wire so that the single positive connector becomes two and the single negative connector becomes two using included 18 AWG wire.

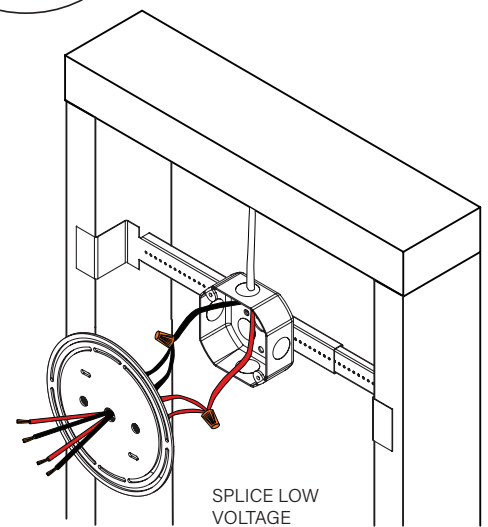
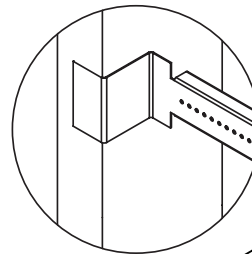

Pivotaire

Picture Frame Installation Instructions

03.

Screw the threaded pipes into the threaded holes indicated below.

NOTE: Center hole is not used in this installation.

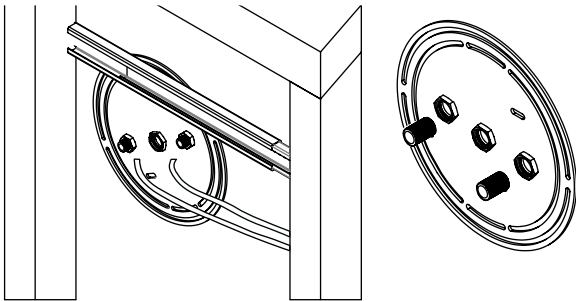

04.

Add the wire strain relief caps to the end of the threaded pipes behind the mounting plate.

- a. Ensure the threaded pipes protrude $\frac{1}{2}$ " from the front of the mounting plate.

05.

Thread the 18 AWG low-voltage wires through the strain relief screws. Have wire protrude from the threaded pipes by about 6 inches. One positive (red) and one negative (black) wire per hole.

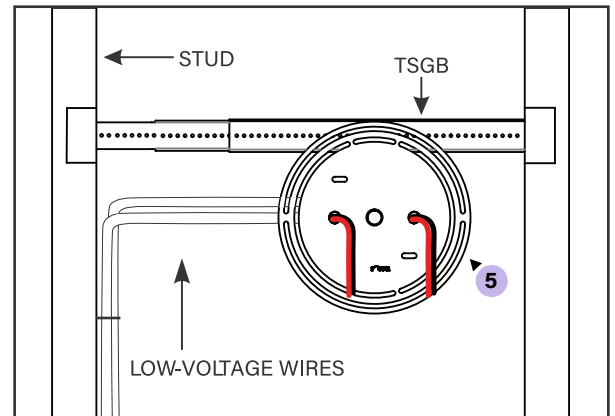
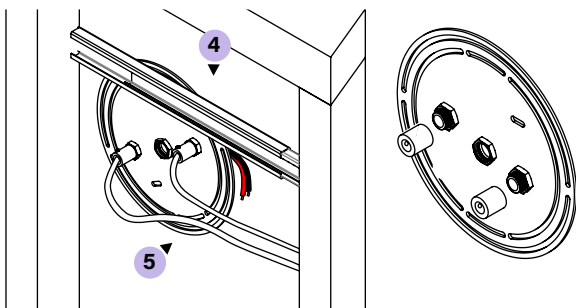

06.

Tighten the strain relief nylon set screw fitting so that it is snug on the wire insulation but not so tight that it damages the insulation.

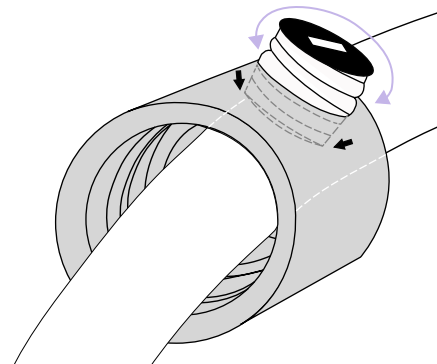

Pivotaire

Picture Frame Installation Instructions

✂ Section Three: Drywall Installation

01.

Assemble the endcap corner and the profile according to the planned layout, using the straight connecting bracket to maintain alignment and the L-bracket for miter corners.

- Insert the straight bracket halfway into the profile rails. Tighten the two M3 set screws on each bracket using a 1.5mm Allen key.
- Slide the other section of the profile onto the bracket and tighten the remaining M3 set screws.

⚠ IMPORTANT: Make sure to position the Pivotaire Powered Corner at the corner to be powered.

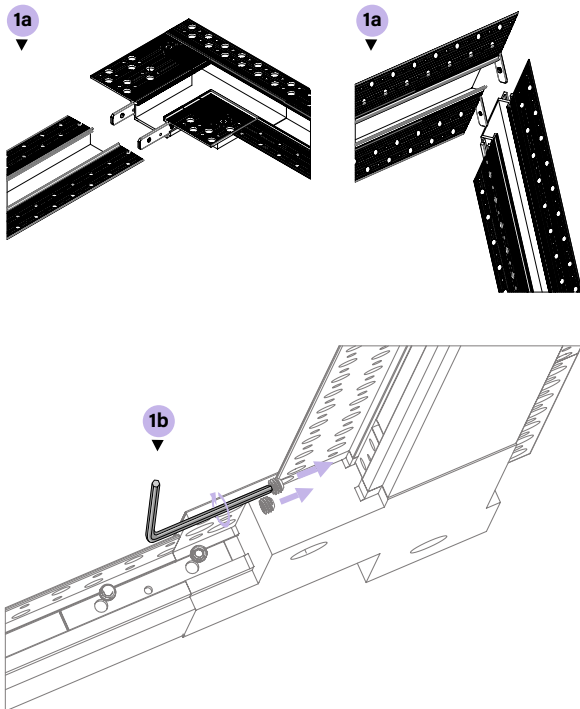

02.

Mark on the drywall where the mounting plate with the wires will be exposed. Drill ½" hole and cut the section using a jab saw to expose the mounting plate.

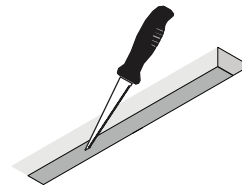

03.

Install drywall.

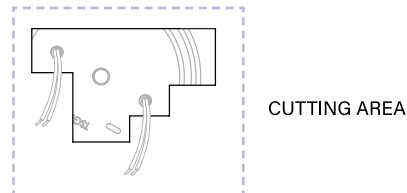

04.

Use the assembled fixture as a guide to mark on the wall where the fixture is to be mounted. Ensure that the holes in the powered endcap align with the threaded pipes.

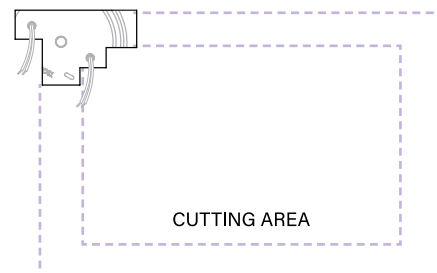

Pivotaire

Picture Frame Installation Instructions

05.

Cut out the marked area matching the length and width of the profile.

- a. Allow for fixture wings to rest on outside of area.

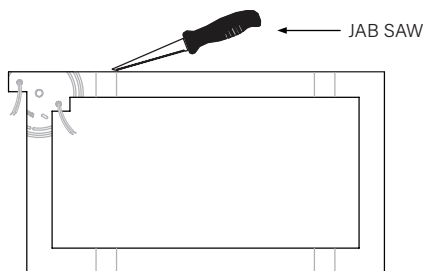

* Profile width varies between models.

- 0.5" Wide Profile
- 1" Wide Profile

Section Four: Mount Profile

NOTE: Optique recommends using drywall screws where studs are present for maximum strength.

If the installation area does not cross studs, please use included drywall anchor.

01.

Install a drywall anchor behind the drywall every 36" where studs are not available.

- Thread a drywall screw into the drywall anchor.
- Place the drywall anchor behind the precut drywall and rotate it into place using the drywall screw as a handle. Secure the drywall anchor to the drywall using two drywall screws.
- Mark the location of the drywall anchors on the drywall for future reference.

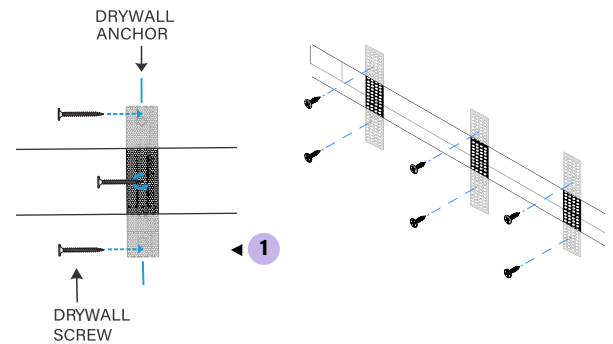

02.

Place the assembled fixture into the cutout area on the wall.

- Thread wires through the holes of the powered corner. Insert into the precut drywall, aligning the holes of the powered corner with the protruding threaded pipes.
- Secure the powered corner by attaching the lock washers and hex nuts to the threaded pipes. Use flat pliers to tighten the nuts.

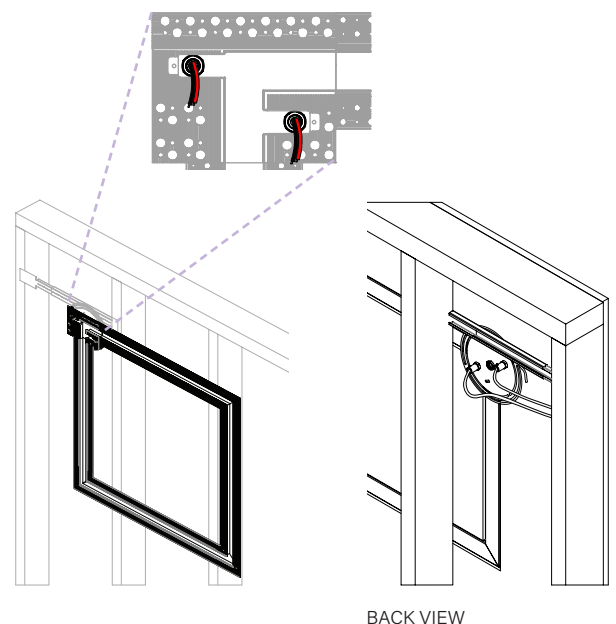

Pivotaire

Picture Frame Installation Instructions

03.

Use supplied 5/8" drywall screws around Pivotaire Powered Corner to ensure the screws do not impact the mounting plate.

- Use standard drywall screws to fasten the fixture to the wall. Properly secure the complete fixture to drywall by screwing through the wings. Use a countersink bit to ensure all screw heads are flush with the profile surface.

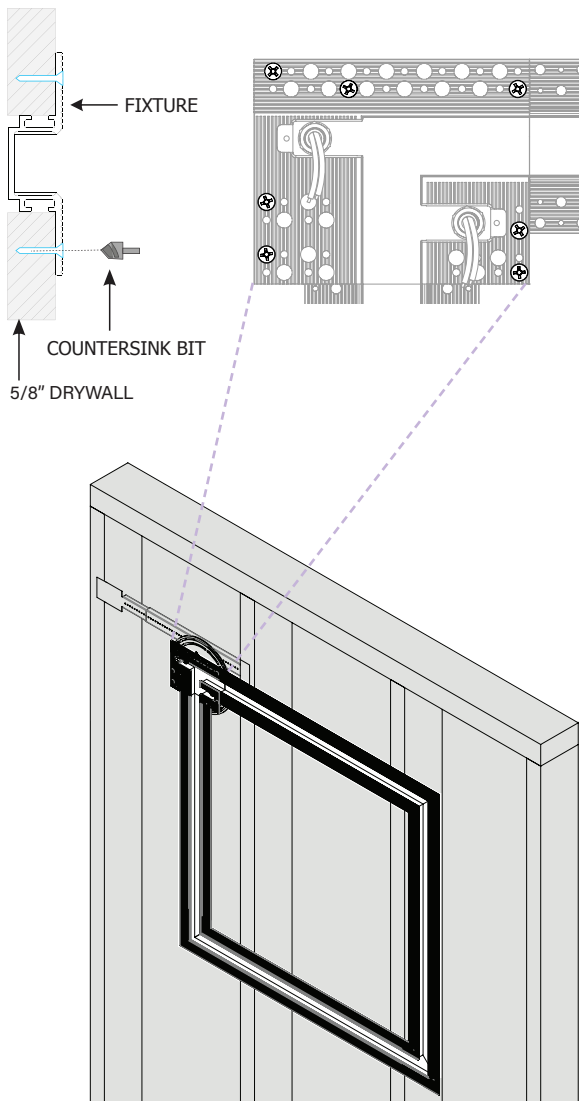

04.

Unwind the tape light from the supplied roll.

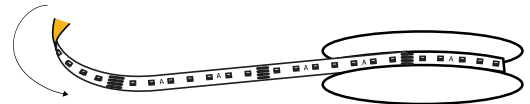

05.

Wire tape light to electrical supply using AmpChamp.

- Test the tape light by connecting a Class 2 LED driver. Turn on the power and ensure the tape lights up.
- Turn off the power again before mounting.

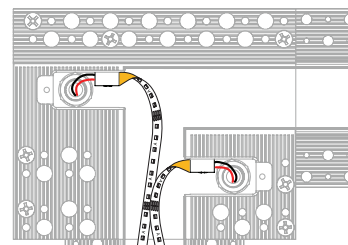

06.

Connect the wires to the AmpChamps, leaving one inch of slack to ensure AmpChamp can be accessed after installation.

- Secure AmpChamps to the Pivotaire Powered Corner with the edge lined up with the fixture using the included 3M VHB tapes.

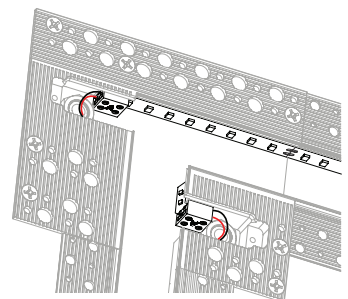

Pivotaire

Picture Frame Installation Instructions

07.

Stick the tape lights to the inside edges of the fixture.

- a. Carefully remove the tape protector from the bottom of the tape light.

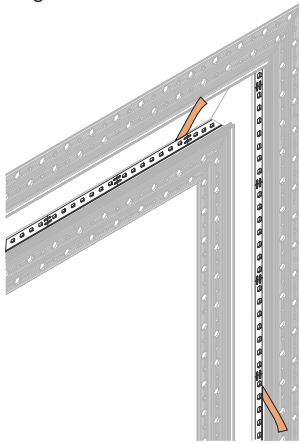

08.

Firmly pressing down using fingers, ensure the tape light is placed along the fixture edges removing the tape protector as needed.

- a. Ensure that the tape light is positioned in corners using your fingers. Do not use tools or hard objects to install the tape light.
- b. Wrap the tape light around until it overlaps the beginning by approximately one inch.

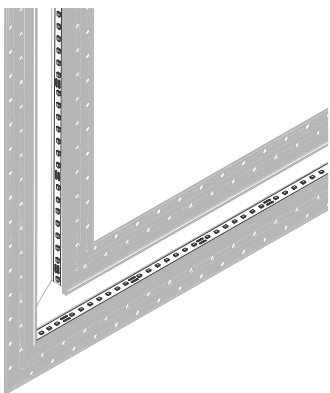

09.

Secure powered corner cover with hex screws provided.

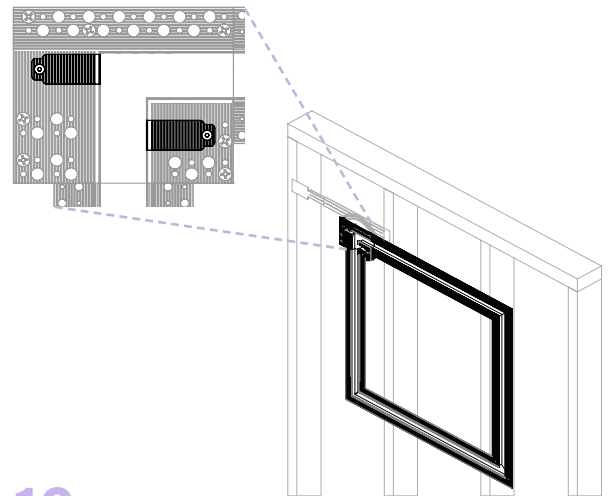

10.

Fasten the lens by firmly pressing one edge into the profile, then the other. Continue pressing the lens along the fixture until fully seated.

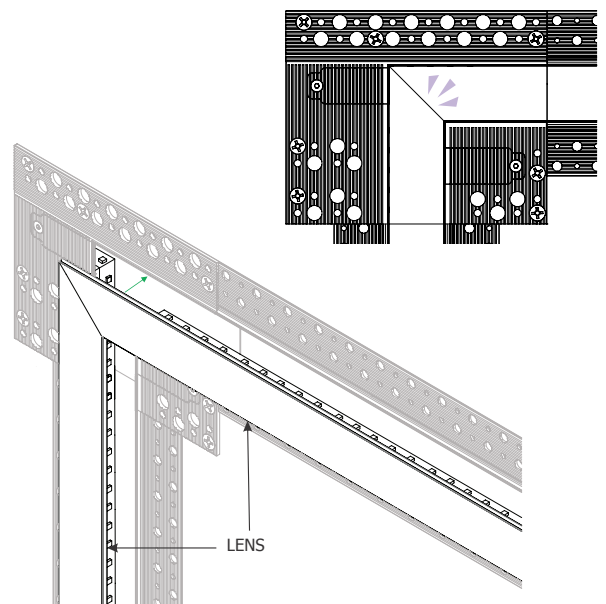

Pivotaire

Picture Frame Installation Instructions

Section Five: Mud-in Profile

01.

Cover the center of the fixture with painter's tape.

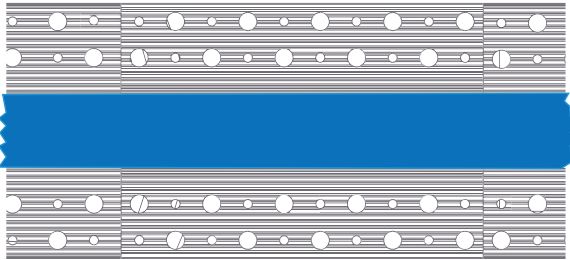

02.

Cover the wings of the fixture with thin drywall tape.

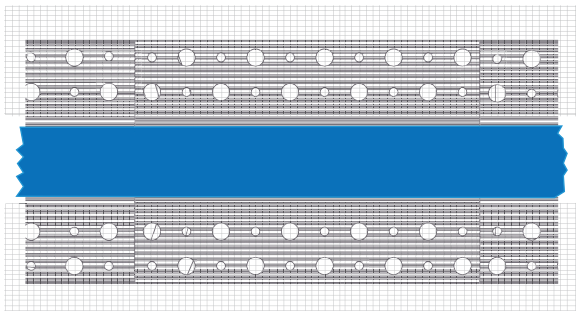

03.

Cover the wings of the fixture with mud.

- a. Wait until it is dry.
- b. Sand the wall.
- c. Repeat if necessary.



04.

Paint the wall and wait until it is dry.

05.

Remove painter's tape.

